

### Dimensions: [mm]

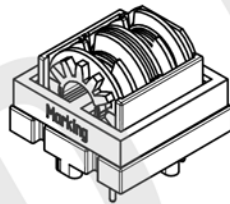
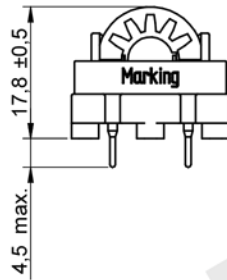
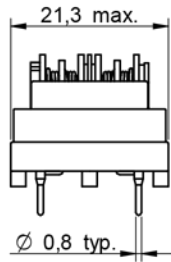
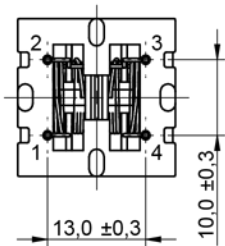

Scale - 1:1

### Product Marking:

Marking	7448640399
---------	------------

### Recommended Hole Pattern: [mm]

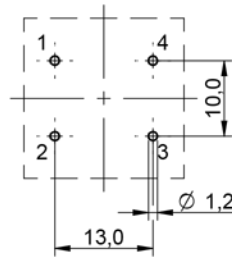

Scale - 1:1

### Schematic:



### Electrical Properties:

Properties		Test conditions	Value	Unit	Tol.
Number of windings	N		2		
Inductance	L	10 kHz/ 100 mV	3.9	mH	min.
Inductance	L	10 kHz/ 100 mV	5.9	mH	typ.
Rated Current	$I_R$	@ 70 °C/ $\Delta T < 55 K$	1.15	A	max.
DC Resistance	$R_{DC}$	@ 20 °C	0.28	$\Omega$	$\pm 15\%$
Rated Voltage	$V_R$	50 Hz	250	V (AC)	max.
Insulation Test Voltage	$V_T$	50 Hz/ 5 mA/ 2 sec.	2000	V (AC)	

### Certification:

RoHS Approval	Compliant [ 2011/65/EU&2015/863 ]
REACH Approval	Conform or declared [ (EC)1907/2006 ]
Component Qualification	AEC-Q200 Grade 1

### General Information:

It is recommended that the temperature of the component does not exceed +125 °C under worst case conditions	
Operating Temperature	-40 up to +125 °C
Ambient Temperature (referring to $I_R$ )	-40 up to +70 °C
Storage Conditions (in original packaging)	< 40 °C ; < 75 % RH
Moisture Sensitivity Level (MSL)	1
Temperature Rise < 55 K	
Test conditions of Electrical Properties: +20 °C, 33 % RH if not specified differently	



Shaanxi FKS Electronic Parts Import&Export Co.,Ltd.  
Address: Building B1, The West Cloud Valley, Fengxi New City,  
Xixian New Area, Xianyang City, Shaanxi Province, China.  
Tel: 0086 29 8868 5333 Fax: 0086 29 8868 0913  
[Http://www.fks-tech.com](http://www.fks-tech.com)

DATE (YYYY-MM-DD) 2019-11-01	GENERAL TOLERANCE DIN ISO 2768-1m	PROJECTION METHOD 
DESCRIPTION <b>Common Mode Power Line Choke</b>		ORDER CODE FKS7448640399
SIZE/TYPE ET20H	STATUS Valid from 2019-11-01 due to PCN	

**Typical Insertion Loss:**

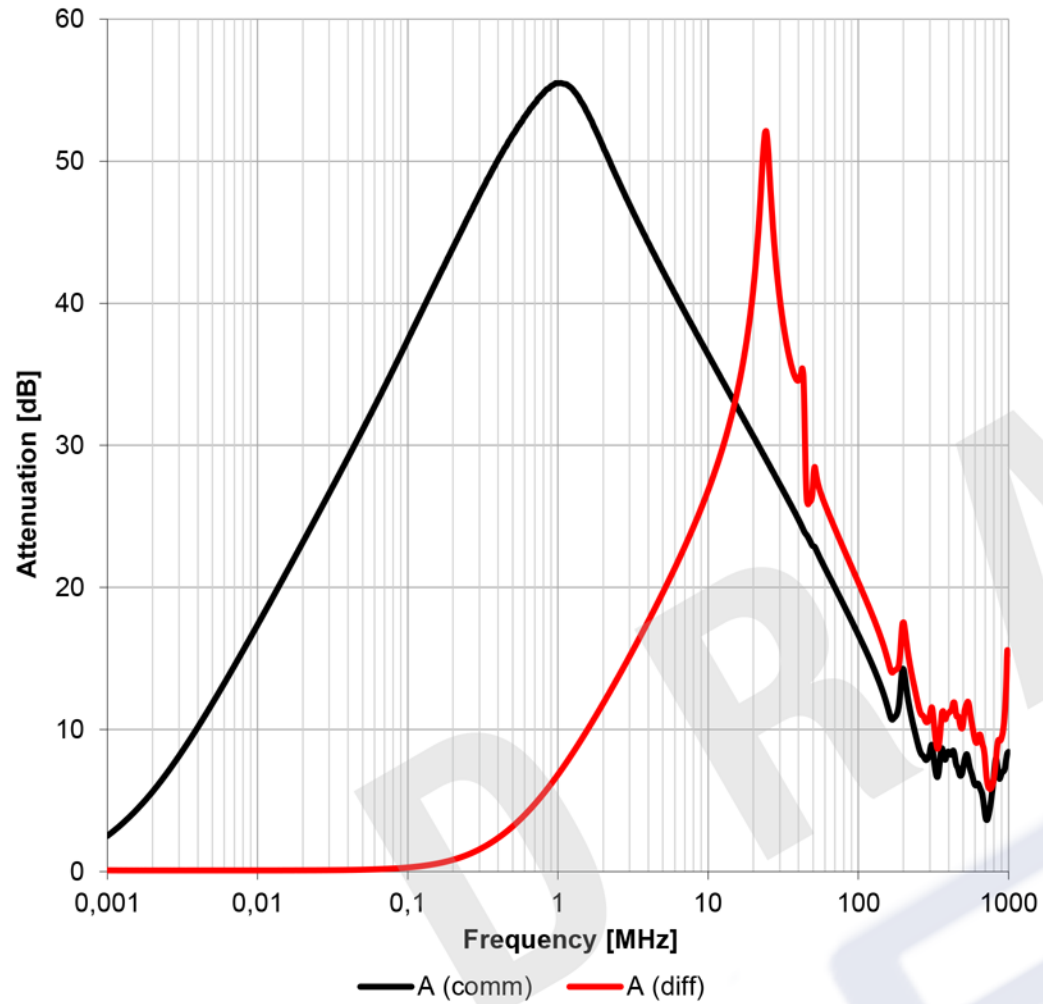

**Typical Impedance Characteristics:**

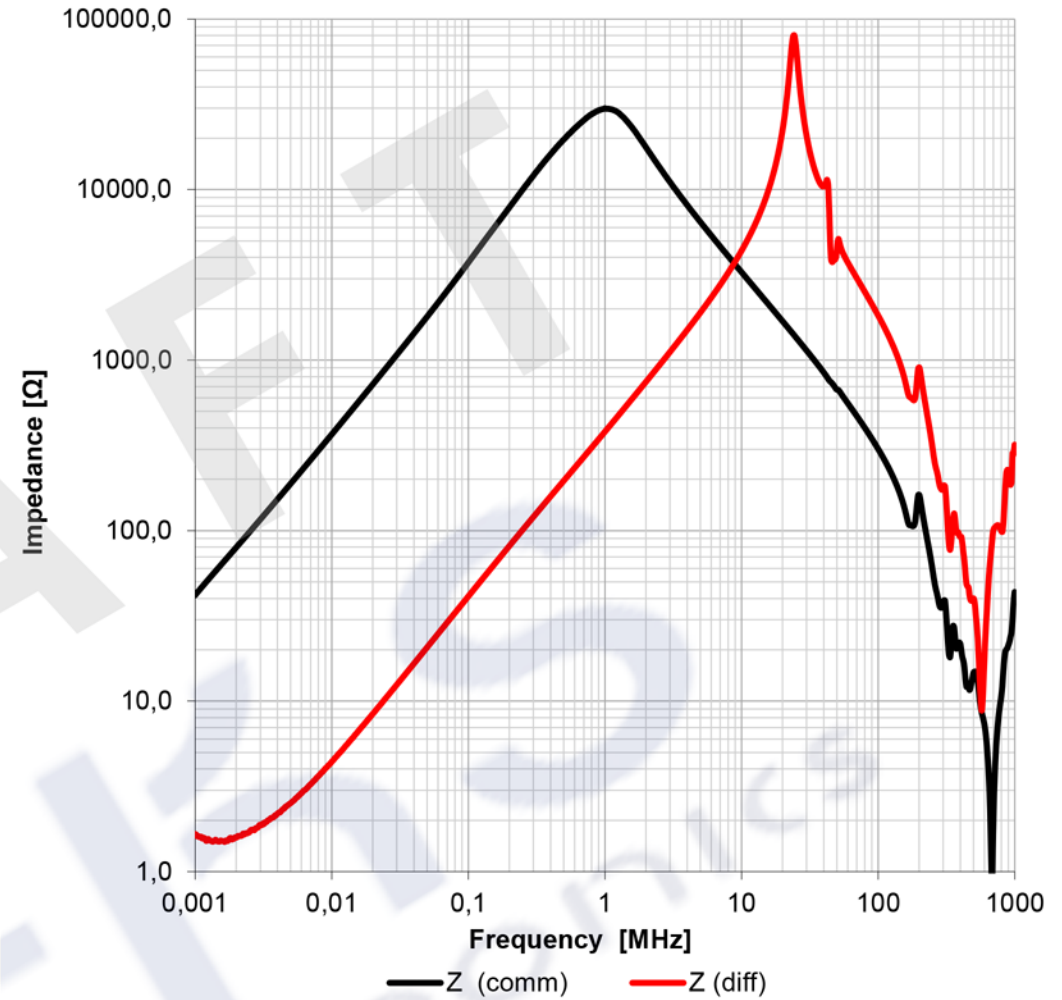

Shaanxi FKS Electronic Parts Import&Export Co.,Ltd.  
 Address: Building B1, The West Cloud Valley, Fengxi New City,  
 Xixian New Area, Xi'an City, Shaanxi Province, China.  
 Tel: 0086 29 8868 5333 Fax: 0086 29 8868 0913  
[Http://www.fks-tech.com](http://www.fks-tech.com)

DATE (YYYY-MM-DD)  
2019-11-01

GENERAL TOLERANCE  
DIN ISO 2768-1m

PROJECTION METHOD

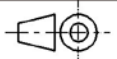

DESCRIPTION  
**Common Mode Power Line Choke**

ORDER CODE  
FKS7448640399

SIZE/TYPE  
ET20H

STATUS  
Valid from 2019-11-01 due to PCN



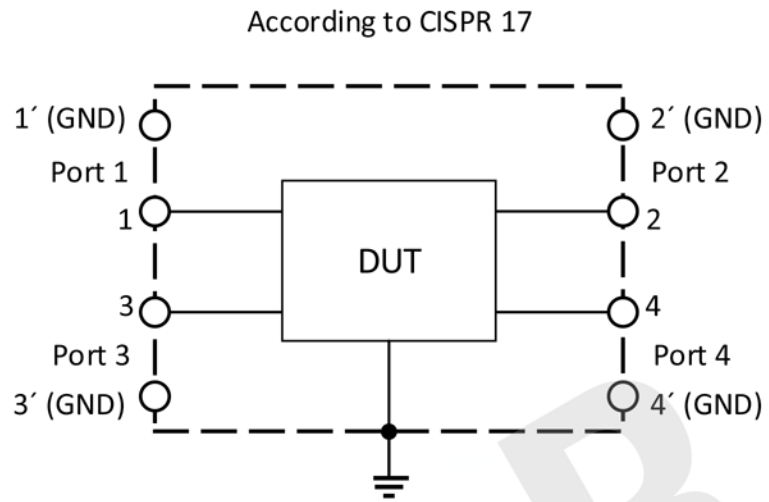



### Test Setup:

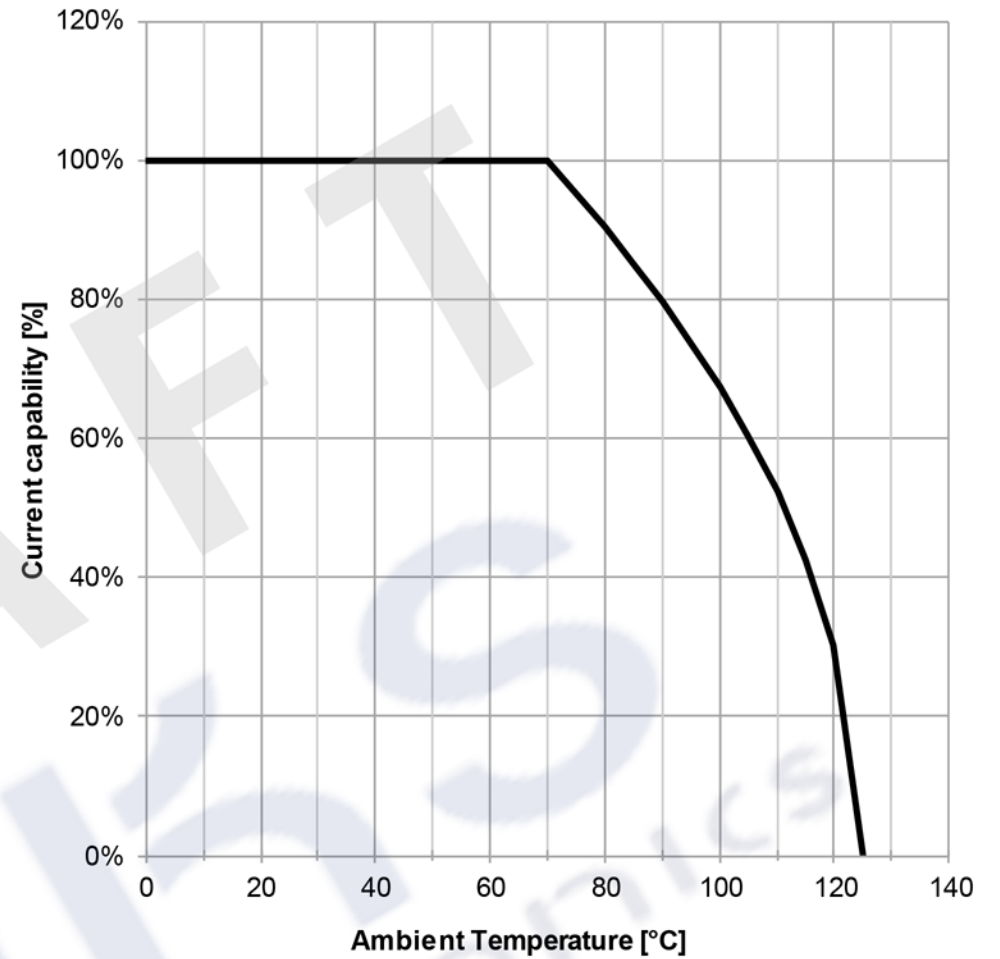

Network Analyzer: Keysight E5080A or equivalent

### Derating Curve:



  	DATE (YYYY-MM-DD) 2019-11-01	GENERAL TOLERANCE DIN ISO 2768-1m	PROJECTION METHOD 
	DESCRIPTION <b>Common Mode Power Line Choke</b>		ORDER CODE FKS7448640399
  Shaanxi FKS Electronic Parts Import&Export Co.,Ltd. Address:Building B1,The West Cloud Valley, Fengxi New City, Xixian New Area,Xianyang City,Shaanxi Province,China. Tel:0086 29 8868 5333 Fax:0086 29 8868 0913 <a href="http://www.fks-tech.com">Http://www.fks-tech.com</a>	SIZE/TYPE ET20H	STATUS Valid from 2019-11-01 due to PCN	

**Packaging Specification - Tray and Carton: [mm]**

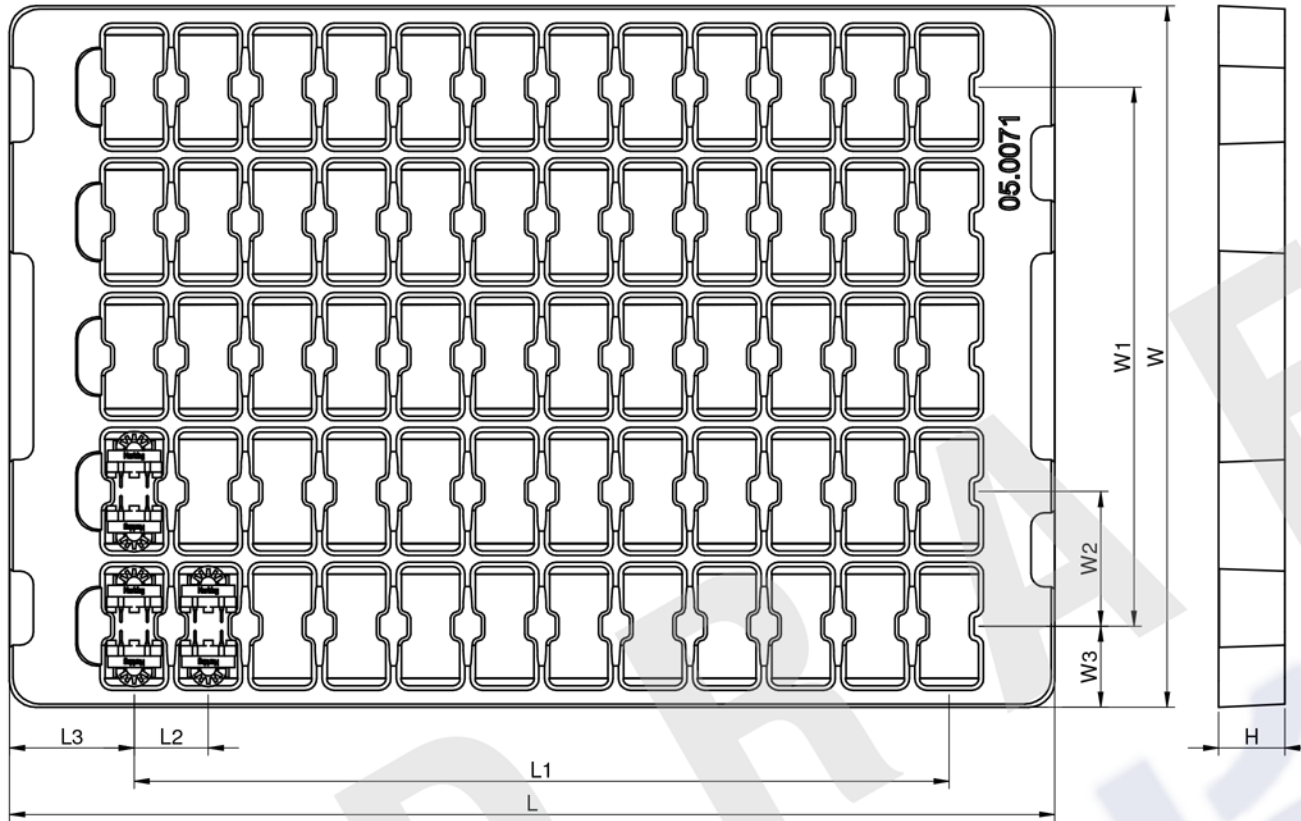

L (mm)	L1 (mm)	L2 (mm)	L3 (mm)	W (mm)	W1 (mm)	W2 (mm)	W3 (mm)	H (mm)	Qty. (pcs.)	Material
typ.	typ.	typ.	typ.	typ.	typ.	typ.	typ.	typ.		
395,00	302,00	27,45	47,10	265,00	214,00	53,50	30,65	25,00	120	PS

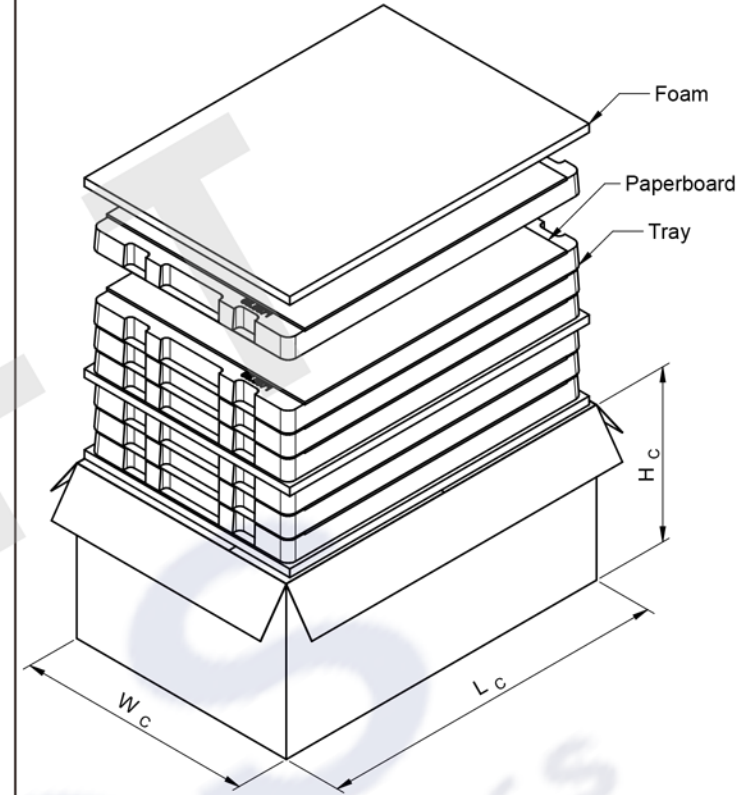

L <sub>c</sub> (mm)	W <sub>c</sub> (mm)	H <sub>c</sub> (mm)	No. of Tray	No. of Paperboard	No. of Foam	Qty. (pcs.)	Material
typ.	typ.	typ.	pcs.	pcs.	pcs.	pcs.	
415,00	280,00	203,00	7	14	3	840	Paper



**FKS**  
Electronics



Shaanxi FKS Electronic Parts Import&Export Co.,Ltd.  
Address: Building B1, The West Cloud Valley, Fengxi New City,  
Xixian New Area, Xianyang City, Shaanxi Province, China.  
Tel: 0086 29 8868 5333 Fax: 0086 29 8868 0913  
[Http://www.fks-tech.com](http://www.fks-tech.com)

DATE (YYYY-MM-DD) 2019-11-01	GENERAL TOLERANCE DIN ISO 2768-1m	PROJECTION METHOD 
DESCRIPTION <b>Common Mode Power Line Choke</b>		ORDER CODE FKS7448640399
SIZE/TYPE ET20H	STATUS Valid from 2019-11-01 due to PCN	

### Classification Wave Soldering Profile:

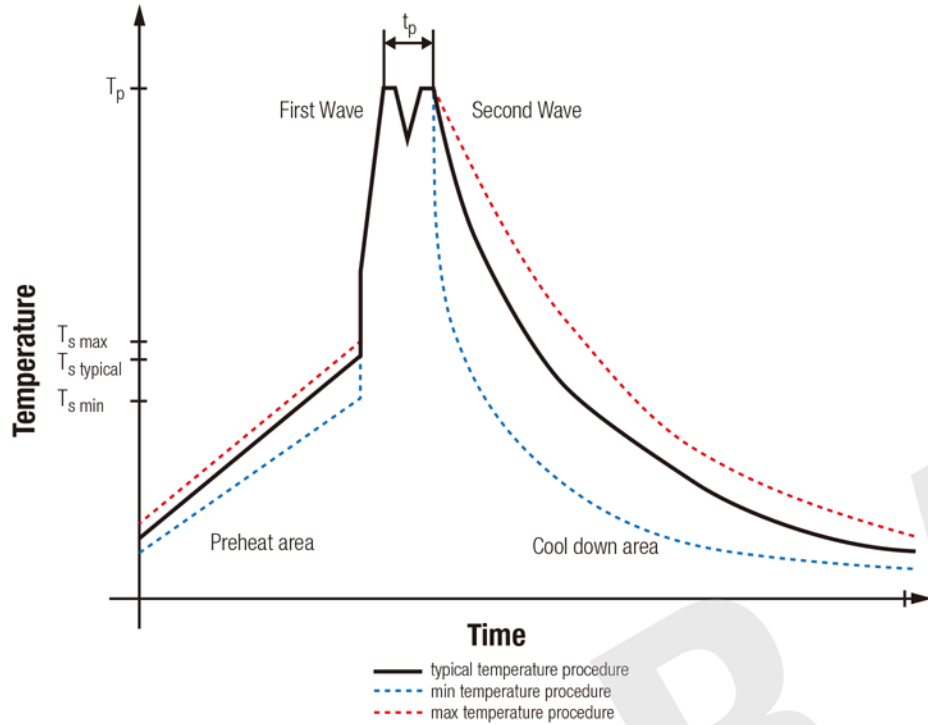

### Classification Wave Soldering Profile:

Profile Feature		Pb-Free Assembly	Sn-Pb Assembly
Preheat Temperature Min	$T_{s \min}$	100 °C	100 °C
Preheat Temperature Typical	$T_{s \text{ typical}}$	120 °C	120 °C
Preheat Temperature Max	$T_{s \max}$	130 °C	130 °C
Preheat Time $t_s$ from $T_{s \min}$ to $T_{s \max}$	$t_s$	70 seconds	70 seconds
Ramp-up Rate	$\Delta T$	150 °C max.	150 °C max.
Peak Temperature	$T_p$	250 °C - 260 °C	235 °C - 260 °C
Time of actual peak temperature	$t_p$	max. 10 seconds max. 5 seconds each wave	max. 10 seconds max. 5 seconds each wave
Ramp-down Rate, Min		~ 2 K/ second	~ 2 K/ second
Ramp-down Rate, Typical		~ 3.5 K/ second	~ 3.5 K/ second
Ramp-down Rate, Max		~ 5 K/ second	~ 5 K/ second
Time 25 °C to 25 °C		4 minutes	4 minutes

refer to EN61760-1:2006

		DATE (YYYY-MM-DD) 2019-11-01	GENERAL TOLERANCE DIN ISO 2768-1m	PROJECTION METHOD 
<p>Shaanxi FKS Electronic Parts Import&amp;Export Co.,Ltd.                  Address:Building B1,The West Cloud Valley, Fengxi New City,                  Xixian New Area,Xianyang City,Shaanxi Province,China.                  Tel:0086 29 8868 5333 Fax:0086 29 8868 0913  <a href="http://www.fks-tech.com">Http://www.fks-tech.com</a></p>		DESCRIPTION <b>Common Mode Power Line Choke</b>		ORDER CODE FKS7448640399
SIZE/TYPE ET20H		STATUS Valid from 2019-11-01 due to PCN		