

Dimensions: [mm]

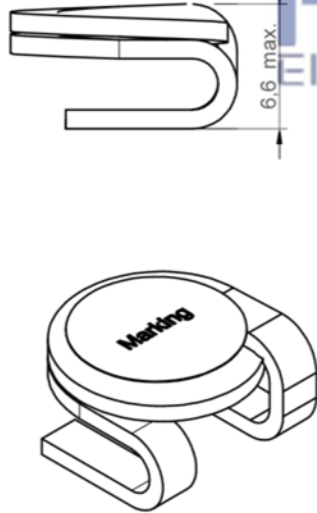

Scale - 2,5:1

Recommended Land Pattern: [mm]

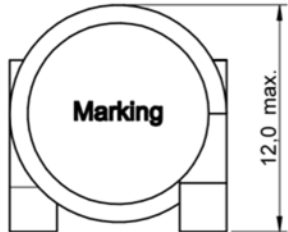
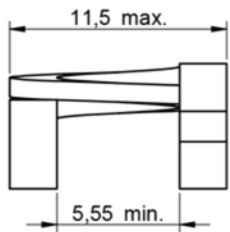
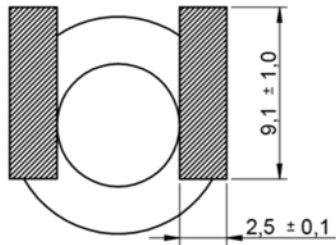
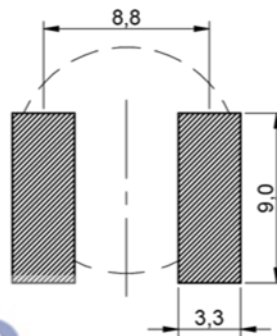

Schematic:



Electrical Properties:

Properties		Test conditions	Value	Unit	Tol.
Inductance	L	1 MHz	22	nH	±20%
Q-Factor	Q	100 MHz	280		typ.
DC Resistance	R _{DC}	@ 20 °C	0.55	mΩ	max.
Rated Current	I _R	ΔT = 40 K	40	A	max.
Self Resonant Frequency	f _{res}		867	MHz	typ.

Certification:

RoHS Approval	Compliant [2011/65/EU&2015/863]
REACH Approval	Conform or declared [(EC)1907/2006]
Halogen Free	Conform [JEDEC JS709B]
Halogen Free	Conform [IEC 61249-2-21]

General Information:

It is recommended that the temperature of the component does not exceed +125 °C under worst case conditions

Ambient Temperature (referring to I _p)	-40 up to +110 °C
Operating Temperature	-40 up to +125 °C
Storage Conditions (in original packaging)	< 40 °C ; < 75 % RH
Moisture Sensitivity Level (MSL)	1
Test conditions of Electrical Properties: +20 °C, 33 % RH if not specified differently	

Product Marking:

Marking	22N (Inductance Code)
Marking - Date Code	T+Year/Month/Day



FKS
Electronics



Shaanxi FKS Electronic Parts Import&Export Co.,Ltd.
Address:Building B1,The West Cloud Valley, Fengxi New City,
Xixian New Area,Xianyang City,Shaanxi Province,China.
Tel:0086 29 8868 5333 Fax:0086 29 8868 0913
[Http://www.fks-tech.com](http://www.fks-tech.com)





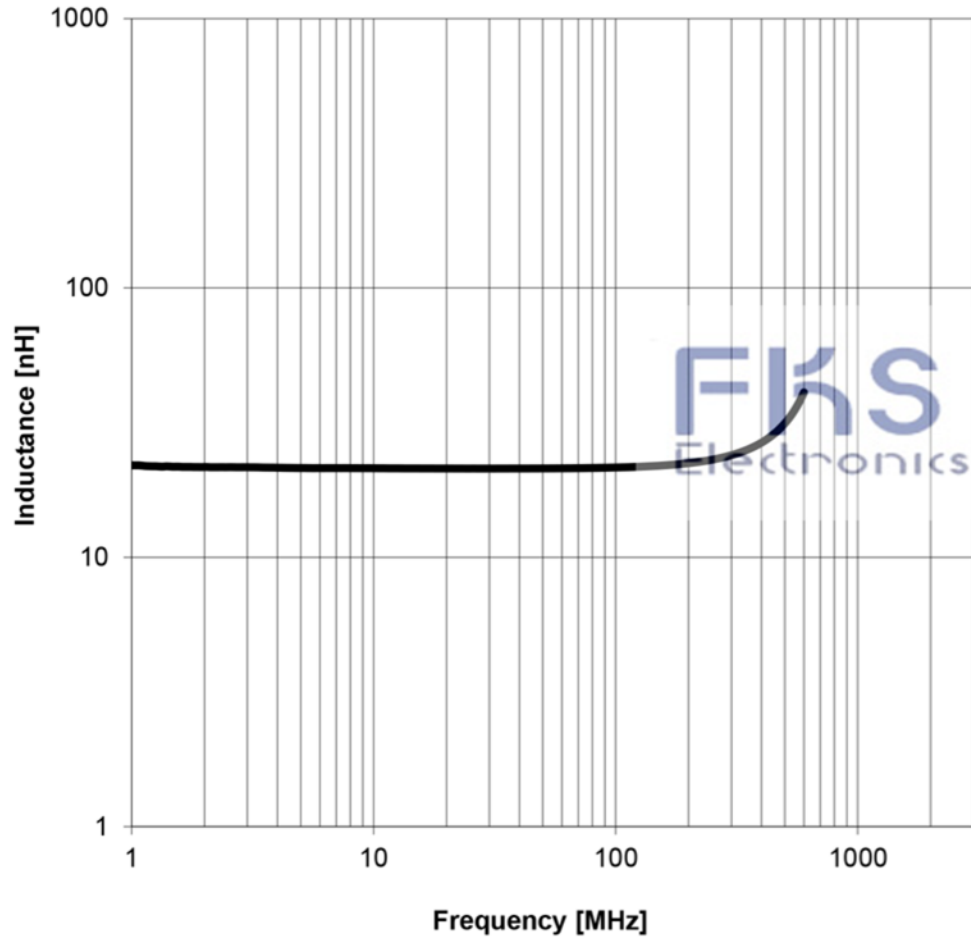

DATE (YYYY-MM-DD)	2019-05-20	GENERAL TOLERANCE	DIN ISO 2768-1m	PROJECTION METHOD	
DESCRIPTION		HC High current air coil		ORDER CODE	
SIZE/TYPE		1212		STATUS	
				Valid	
				FKS7449152022	

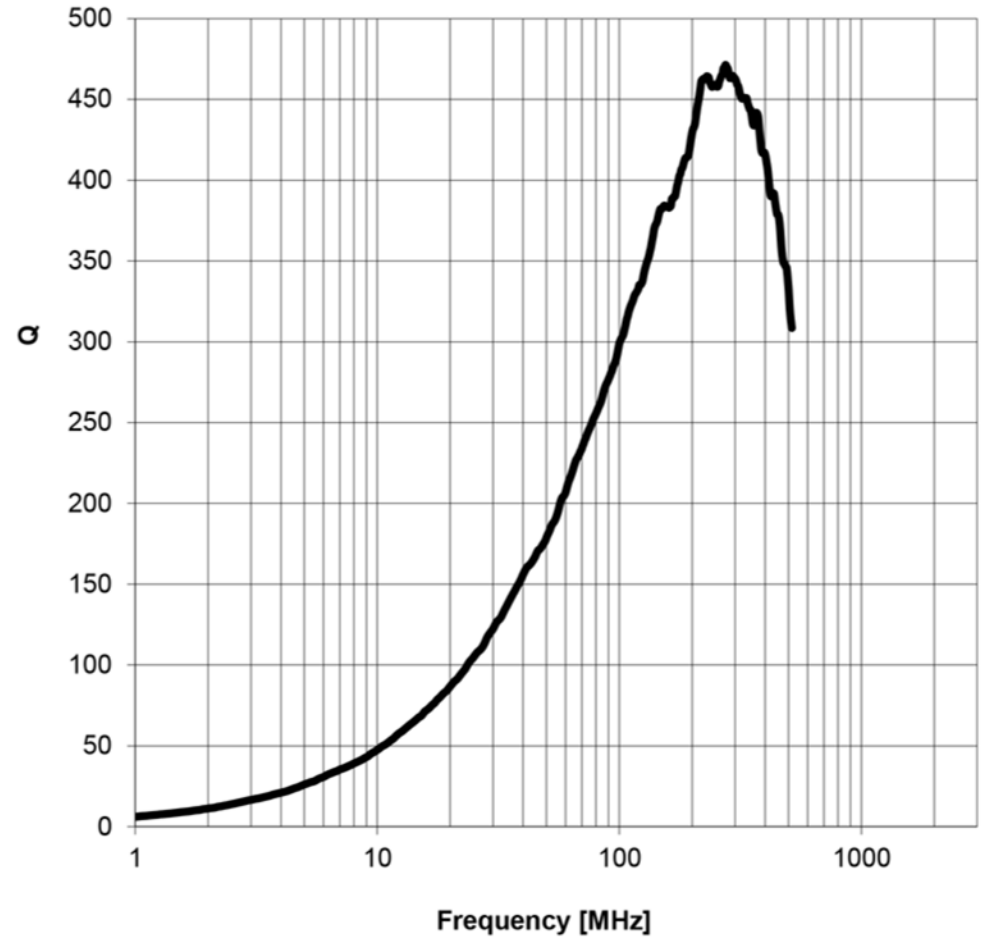
Typical Inductance vs. Frequency Characteristics:



Q-Factor vs. Frequency:



  	DATE (YYYY-MM-DD) 2019-05-20	GENERAL TOLERANCE DIN ISO 2768-1m	PROJECTION METHOD 
	DESCRIPTION HC High current air coil		ORDER CODE FKS7449152022
  Shaanxi FKS Electronic Parts Import&Export Co.,Ltd. Address:Building B1,The West Cloud Valley, Fengxi New City, Xixian New Area,Xianyang City,Shaanxi Province,China. Tel:0086 29 8868 5333 Fax:0086 29 8868 0913 Http://www.fks-tech.com	SIZE/TYPE 1212	STATUS Valid	

Packaging Specification - Tape and Reel: [mm]

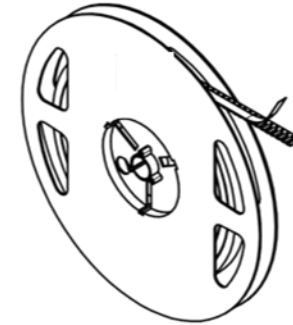
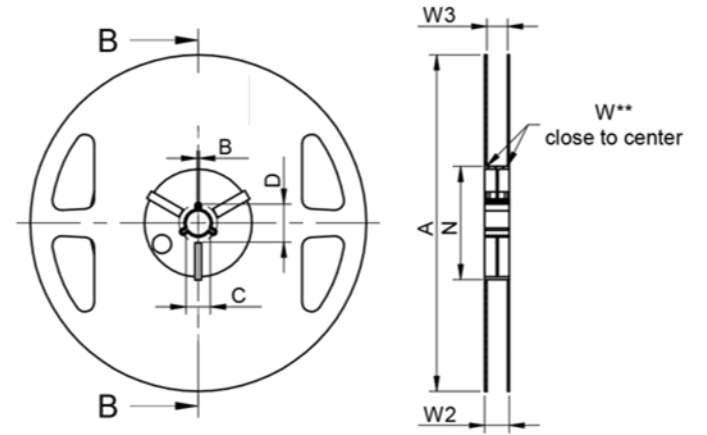
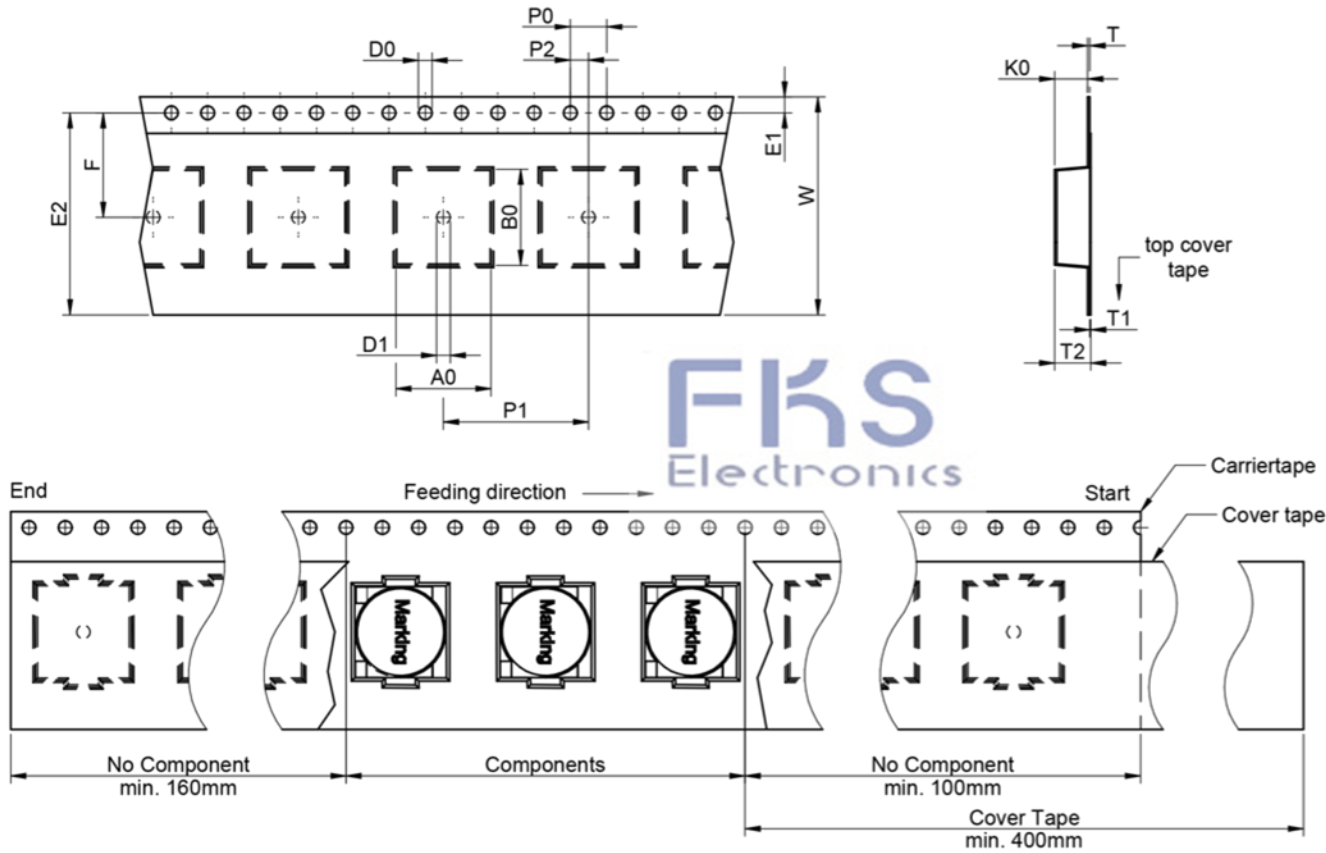

Packaging is referred to the international standard IEC 60286 -3:2007

	A0	B0	W	T	T1	T2	K0	P0	P1	P2	D0	D1	E1	E2	F	Tape Type 2a	VPE / packaging unit
tolerance	±0,1	±0,1	±0,1	typ. max.	typ.	typ.	±0,15	±0,1	±0,1	±0,1	+0,1/-0,0	min. ±0,1	min.	min.	±0,1		pcs.
size	1212	12,50	12,50	24,00	0,50	0,10	7,40	6,90	4,00	16,00	2,00	1,50	1,75	22,25	11,50	Polystyrene	450

	A	B	C	D	N	W1	W2	W3	W3	
Tolerance	± 2,0	min.	min.	min.	± 2,0	+ 2	max.	min.	max.	
Tape width	24mm	330,00	1,50	12,80	20,20	60,00	24,40	30,40	23,90	27,40

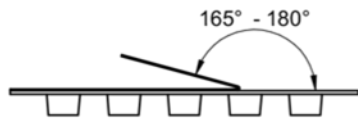

	Pull-of force
Tape width	24 mm
	0,1 N - 1,3 N

	DATE (YYYY-MM-DD)	GENERAL TOLERANCE	PROJECTION METHOD
	2019-05-20	DIN ISO 2768-1m	
	DESCRIPTION		ORDER CODE
	HC High current air coil		FKS7449152022
	SIZE/TYPE	STATUS	
	1212	Valid	

Shaanxi FKS Electronic Parts Import&Export Co.,Ltd.
 Address: Building B1, The West Cloud Valley, Fengxi New City
 Xixian New Area, Xianyang City, Shaanxi Province, China.
 Tel: 0086 29 8868 5333 Fax: 0086 29 8868 0913
<http://www.fks-tech.com>

Classification Reflow Profile for SMT components:

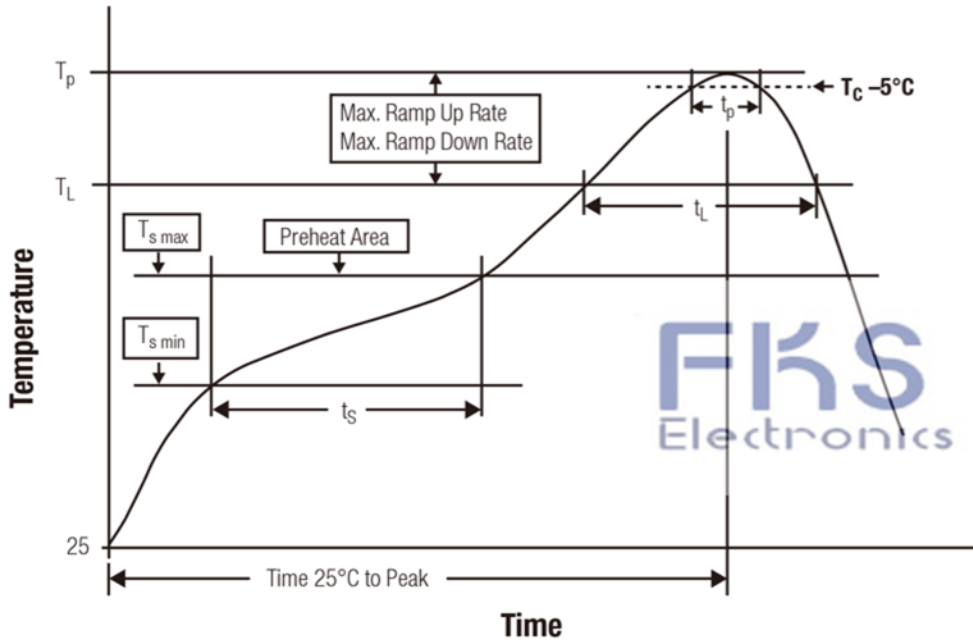

Classification Reflow Soldering Profile:

Profile Feature		Value
Preheat Temperature Min	$T_{s\ min}$	150 °C
Preheat Temperature Max	$T_{s\ max}$	200 °C
Preheat Time t_s from $T_{s\ min}$ to $T_{s\ max}$	t_s	60 - 120 seconds
Ramp-up Rate (T_L to T_p)		3 °C/ second max.
Liquidous Temperature	T_L	217 °C
Time t_L maintained above T_L	t_L	60 - 150 seconds
Peak package body temperature	T_p	see table below
Time within 5°C of actual peak temperature	t_p	20 - 30 seconds
Ramp-down Rate (T_L to T_p)		6 °C/ second max.
Time 25°C to peak temperature		8 minutes max.

refer to IPC/ JEDEC J-STD-020E

Package Classification Reflow Temperature:

Properties	Volume mm ³ <350	Volume mm ³ 350-2000	Volume mm ³ >2000
PB-Free Assembly Package Thickness < 1.6 mm	260 °C	260 °C	260 °C
PB-Free Assembly Package Thickness 1.6 mm - 2.5 mm	260 °C	250 °C	245 °C
PB-Free Assembly Package Thickness ≥ 2.5 mm	250 °C	245 °C	245 °C

refer to IPC/ JEDEC J-STD-020E



FKS
Electronics



Shaanxi FKS Electronic Parts Import&Export Co.,Ltd.
Address:Building B1,The West Cloud Valley, Fengxi New City
Xixian New Area,Xianyang City,Shaanxi Province,China.
Tel:0086 29 8868 5333 Fax:0086 29 8868 0913
[Http://www.fks-tech.com](http://www.fks-tech.com)

DATE (YYYY-MM-DD)
2019-05-20

GENERAL TOLERANCE
DIN ISO 2768-1m

PROJECTION
METHOD



DESCRIPTION

HC High current air coil

ORDER CODE

FKS7449152022

SIZE/TYPE

1212

STATUS

Valid