

Dimensions: [mm]

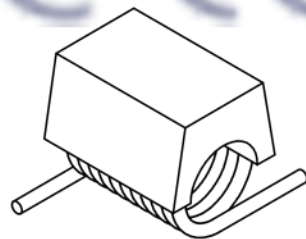

Scale - 5:1

Recommended Land Pattern: [mm]

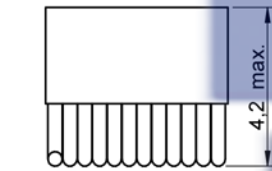
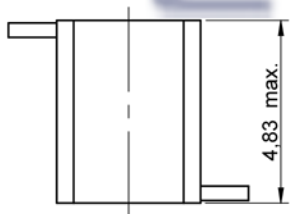
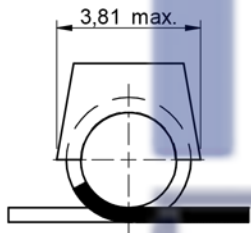
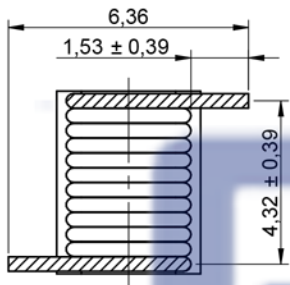
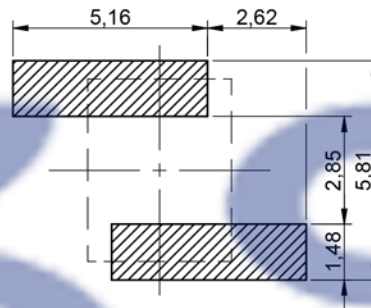

Scale - 5:1

Schematic:



Electrical Properties:

Properties		Test conditions	Value	Unit	Tol.
Inductance	L	150 MHz	82	nH	±5%
Q-Factor	Q	150 MHz	100		min.
DC Resistance	R _{DC}	@ 20 °C	9.4	mΩ	max.
Rated Current	I _R	ΔT = 15 K	2.5	A	max.
Self Resonant Frequency	f _{res}		1.3	GHz	min.

Certification:

RoHS Approval	Compliant [2011/65/EU&2015/863]
REACH Approval	Conform or declared [(EC)1907/2006]
Halogen Free	Conform [JEDEC JS709B]
Halogen Free	Conform [IEC 61249-2-21]

General Information:

It is recommended that the temperature of the component does not exceed +125 °C under worst case conditions	
Ambient Temperature (referring to I _R)	-40 up to +110 °C
Operating Temperature	-40 up to +125 °C
Storage Conditions (in original packaging)	< 40 °C ; < 75 % RH
Moisture Sensitivity Level (MSL)	1
Test conditions of Electrical Properties: +20 °C, 33 % RH if not specified differently	



FKS
Electronics



Shaanxi FKS Electronic Parts Import&Export Co.,Ltd.
Address:Building B1,The West Cloud Valley, Fengxi New City,
Xixian New Area,Xianyang City,Shaanxi Province,China.
Tel:0086 29 8868 5333 Fax:0086 29 8868 0913
[Http://www.fks-tech.com](http://www.fks-tech.com)

DATE (YYYY-MM-DD)
2019-05-29

GENERAL TOLERANCE
DIN ISO 2768-1m

PROJECTION METHOD



DESCRIPTION

Air coil

ORDER CODE

FKS744912182

SIZE/TYPE

4248

STATUS





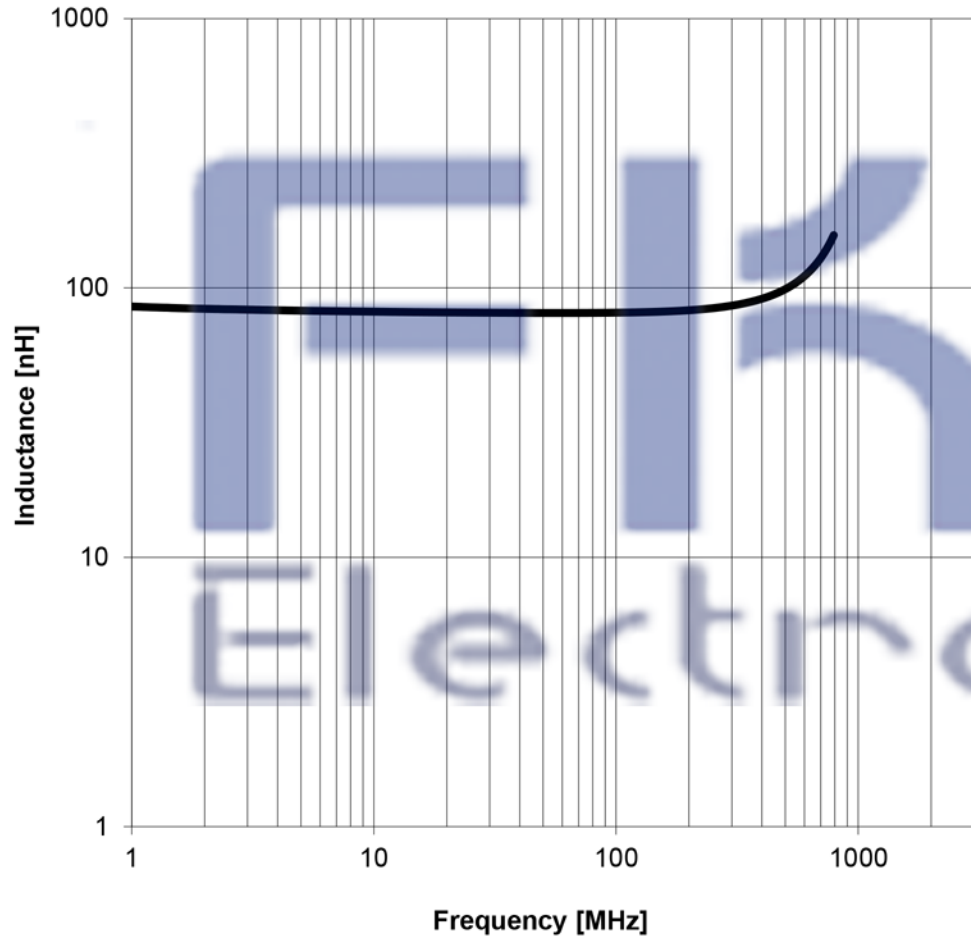

Valid

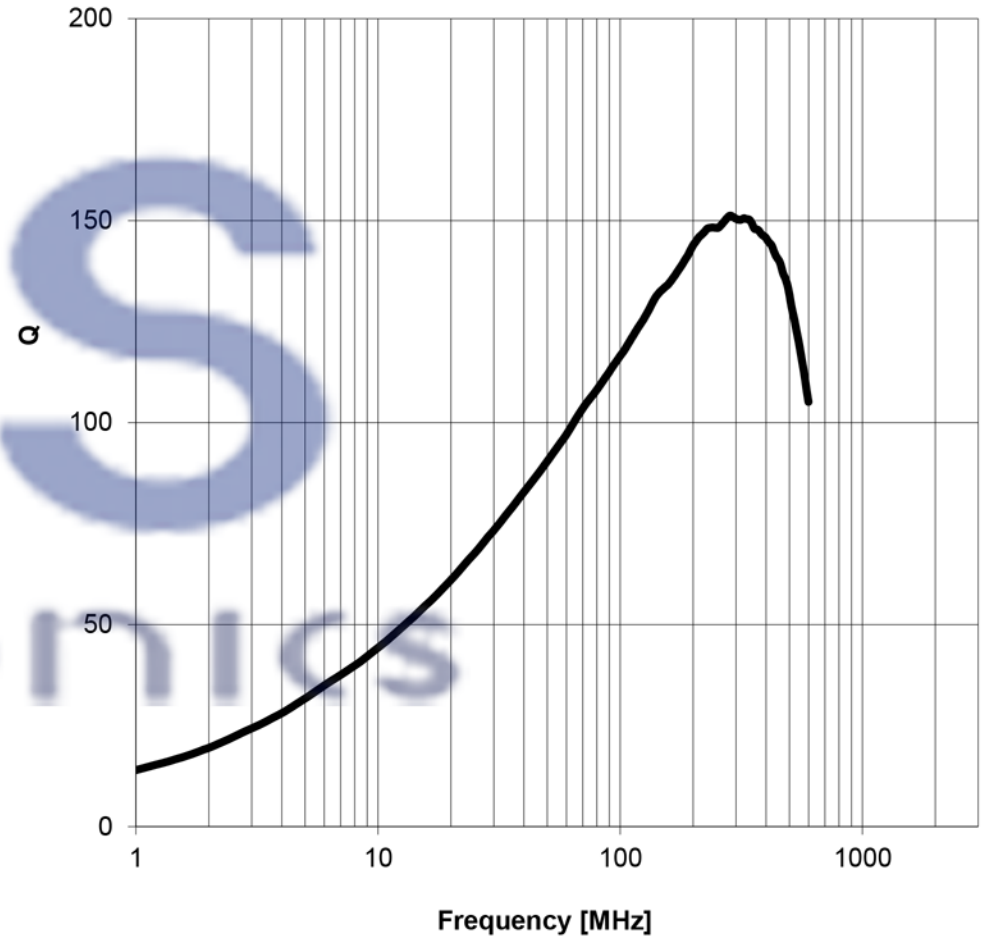
Typical Inductance vs. Frequency Characteristics:



Q-Factor vs. Frequency:



  	DATE (YYYY-MM-DD) 2019-05-29	GENERAL TOLERANCE DIN ISO 2768-1m	PROJECTION METHOD 
	DESCRIPTION Air coil		ORDER CODE FKS744912182
  Shaanxi FKS Electronic Parts Import&Export Co.,Ltd. Address:Building B1,The West Cloud Valley, Fengxi New City, Xixian New Area,Xianyang City,Shaanxi Province,China. Tel:0086 29 8868 5333 Fax:0086 29 8868 0913 Http://www.fks-tech.com	SIZE/TYPE 4248	STATUS Valid	

Packaging Specification - Tape and Reel: [mm]

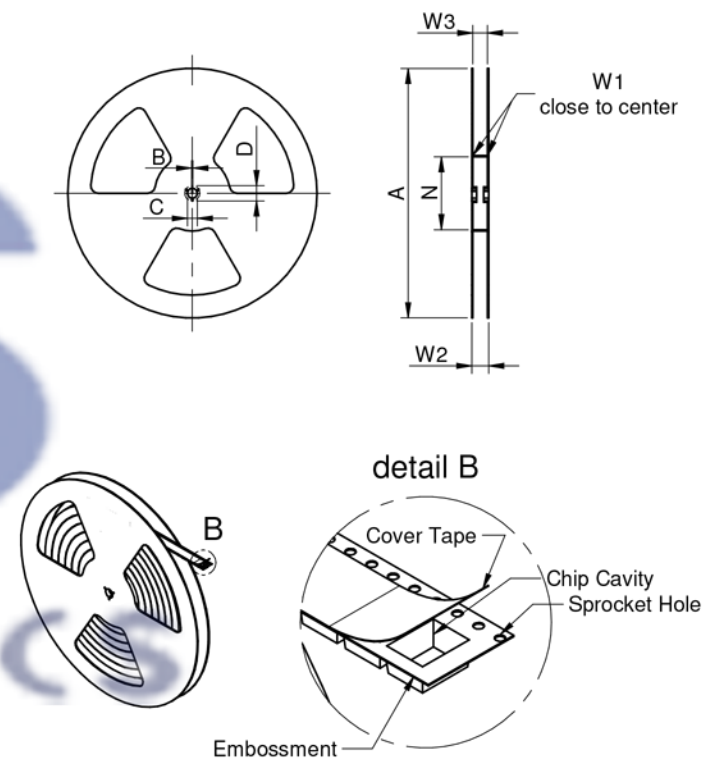
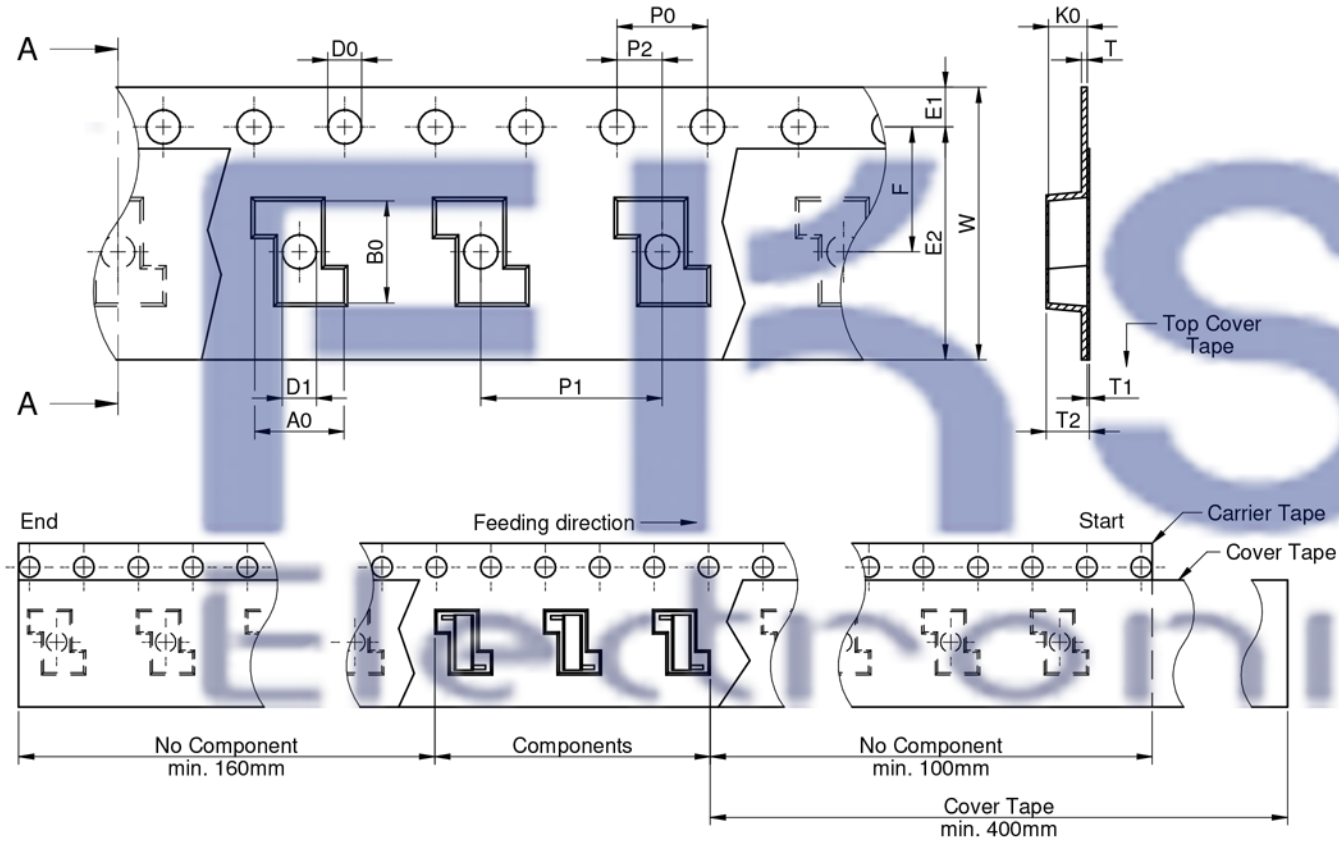

Tape Type	A0 (mm)	B0 (mm)	W (mm)	T (mm)	T1 (mm)	T2 (mm)	K0 (mm)	P0 (mm)	P1 (mm)	P2 (mm)	D0 (mm)	D1 (mm)	E1 (mm)	E2 (mm)	F (mm)	Material	Qty. (pcs.)
	typ.	typ.	+0,3/-0,1	max.	ref.	typ.	typ.	±0,1	±0,1	±0,1	+0,1/-0,0	min.	±0,1	min.	±0,1		
2a	9,50	5,50	16,00	0,60	0,10	4,90	4,70	4,00	12,00	2,00	1,50	1,50	1,75	14,25	7,50	Polystyrene	1000

A (mm)	B (mm)	C (mm)	D (mm)	N (mm)	W1 (mm)	W2 (mm)	W3 (mm)	W3 (mm)	Material
± 2,0	min.	min.	min.	min.	+ 2,0	max.	min.	max.	Polystyrene/ Polyurethane
330,00	1,50	12,80	20,20	60,00	16,40	22,40	15,90	19,40	

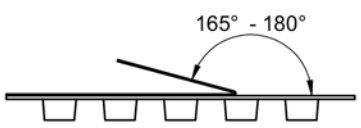

		Pull-of force
Tape width	16 mm	0,1 N - 1,3 N

		DATE (YYYY-MM-DD) 2019-05-29	GENERAL TOLERANCE DIN ISO 2768-1m	PROJECTION METHOD
DESCRIPTION <h2 style="text-align: center;">Air coil</h2>			ORDER CODE <h2 style="text-align: center;">FKS744912182</h2>	
FKS Electronics Shaanxi FKS Electronic Parts Import&Export Co.,Ltd. Address: Building B1, The West Cloud Valley, Fengxi New City, Xixian New Area, Xianyang City, Shaanxi Province, China. Tel: 0086 29 8868 5333 Fax: 0086 29 8868 0913 Http://www.fks-tech.com		SIZE/TYPE 4248	STATUS Valid	

Classification Reflow Profile for SMT components:

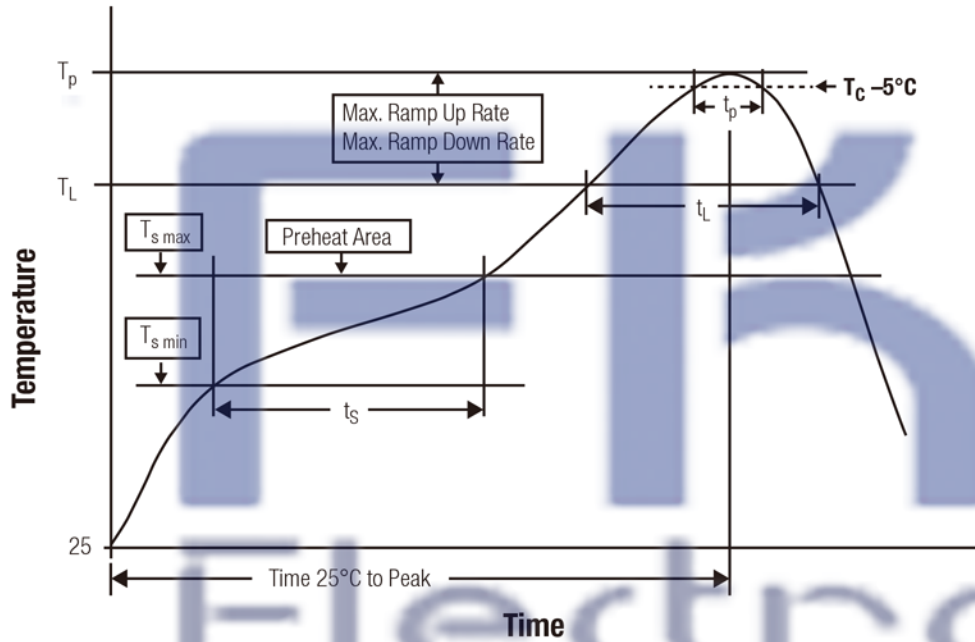

Classification Reflow Soldering Profile:

Profile Feature		Value
Preheat Temperature Min	$T_{s \text{ min}}$	150 °C
Preheat Temperature Max	$T_{s \text{ max}}$	200 °C
Preheat Time t_s from $T_{s \text{ min}}$ to $T_{s \text{ max}}$	t_s	60 - 120 seconds
Ramp-up Rate (T_L to T_p)		3 °C/ second max.
Liquidous Temperature	T_L	217 °C
Time t_L maintained above T_L	t_L	60 - 150 seconds
Peak package body temperature	T_p	see table below
Time within 5°C of actual peak temperaure	t_p	20 - 30 seconds
Ramp-down Rate (T_L to T_p)		6 °C/ second max.
Time 25°C to peak temperature		8 minutes max.

refer to IPC/ JEDEC J-STD-020E

Package Classification Reflow Temperature:

Properties	Volume mm ³ <350	Volume mm ³ 350-2000	Volume mm ³ >2000
PB-Free Assembly Package Thickness < 1.6 mm	260 °C	260 °C	260 °C
PB-Free Assembly Package Thickness 1.6 mm - 2.5 mm	260 °C	250 °C	245 °C
PB-Free Assembly Package Thickness ≥ 2.5 mm	250 °C	245 °C	245 °C

refer to IPC/ JEDEC J-STD-020E

	DATE (YYYY-MM-DD)	GENERAL TOLERANCE	PROJECTION METHOD
	2019-05-29	DIN ISO 2768-1m	
 Shaanxi FKS Electronic Parts Import&Export Co.,Ltd. Address:Building B1,The West Cloud Valley, Fengxi New City, Xixian New Area,Xianyang City,Shaanxi Province,China. Tel:0086 29 8868 5333 Fax:0086 29 8868 0913 Http://www.fks-tech.com	DESCRIPTION		ORDER CODE
	Air coil		FKS744912182
SIZE/TYPE		STATUS	
4248		Valid	